

We trade all values in the world.



WHITEPAPER

V 1.0

## **ABSTRACT**

As technology develops, the amount of information is rapidly increasing. In these circumstances, a lot of valuable information is often not available for those who need it. The criteria for judging value is constantly changing depending on time, space and situation. For example, when a patient with a specific disease wants to find a hospital that treats well the disease, the information about such a hospital is very valuable to the patient. However, when the disease become worse, such information may lose much of its value. The CLEBUS Project wants to share real-time value so that this kind of information can be shared appropriately according to the circumstance, time and space.

We get information through various media including portal sites, blogs, YouTube, etc. However, the information from these media may be secondly processed or it is difficult to access it in real time. Therefore, we want to create diverse ecosystems so that information can be used in real life through raw keyword-based artificial intelligence (AI) search, real-time sharing, and evaluation of shared values.

CLEBUS Project publishes CLE Coin, a cryptocurrency to be used in the CLEBUS Platform and builds a platform coin economy based on it. Participants who contribute to the platform ecosystem are rewarded according to their contribution, and data providers are also rewarded according to the value of the data they provide. If you provide high-value data, you can get more rewards, and the value of data is calculated based on users' evaluations and frequency of data use.

CLEBUS Project participants can use these acquired virtual currency for using other services or receiving rewards. CLEBUS Project will contribute to creating an environment where users can freely exchange valuable data according to the necessity and lead to the development of the platform. We believe that we can greatly contribute to the realization of humanity by leading innovation in value sharing and creating a virtuous cycle in the platform ecosystem.

# TABLE OF CONTENTS

---

ABSTRACT	-----	02
1.0. MARKET STATUS	-----	04
2.0. CLEBUS Project Introduction	-----	08
3.0. CLEBUS TECH	-----	14
4.0. COIN DISTRIBUTION	-----	20
5.0 ROAD MAP	-----	22
6.0 DISCLAIMER	-----	24



PART 1.0.

# Market Status



## PART 1.0 MARKET STATUS

### 1.1. Value of Information

[Big Data Global Market Outlook]

(Unit: 100 million dollars)

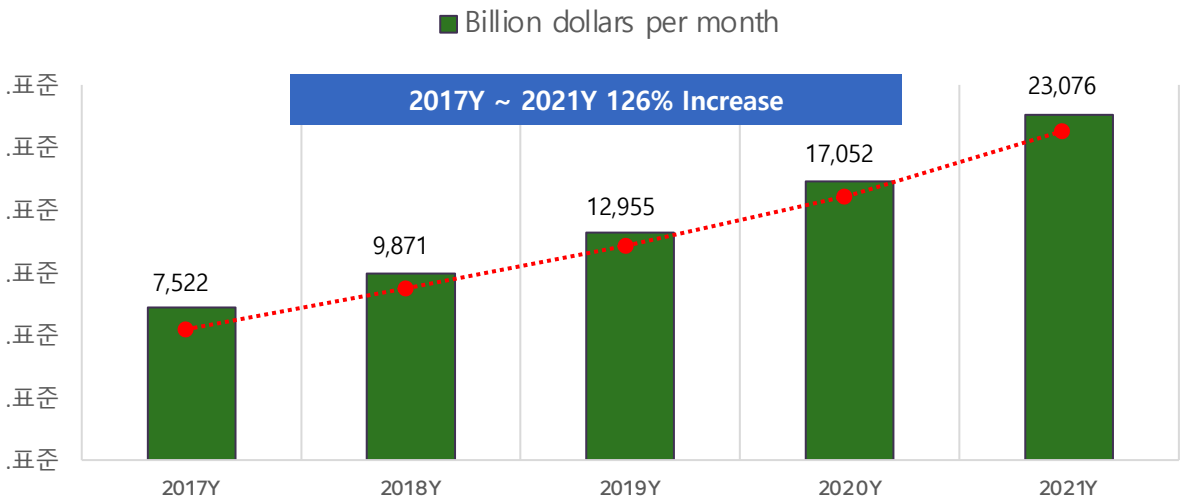

(Source : Fusion Analytics World)

[Changing Global Data Paradigm]

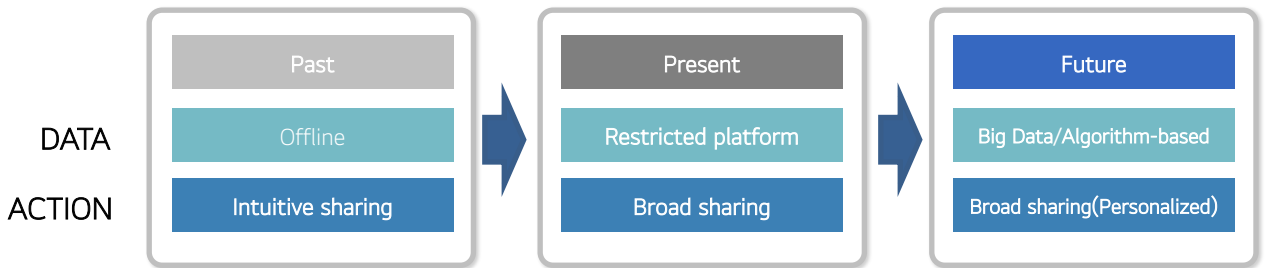

- In the 20th century, information meant competitiveness with which people preoccupy power and important things. Peter Drucker said, "Knowledge is the most important resource of the economy and will become the most dominant competitive factor". The importance of such knowledge has become a determining factor in the rise and fall of companies and countries.
- According to the market research agency Fusion Analytics World, the size of Big Data market is expected to reach \$ 2,307.6 billion in 2021 by growing average 31.5% annually from \$ 752.2 billion in 2017. In recent years, as digitalization accelerates worldwide, various types of information recorded on the paper in the past have been computerized and accumulated as data. Data is exponentially increasing as my data concept is expanding, where the data a specific platform manage is managed by an individual who becomes an information subject.

## PART 1.0 MARKET STATUS

### 1.2. Change of information

[Change of Information Content through SNS Industry]

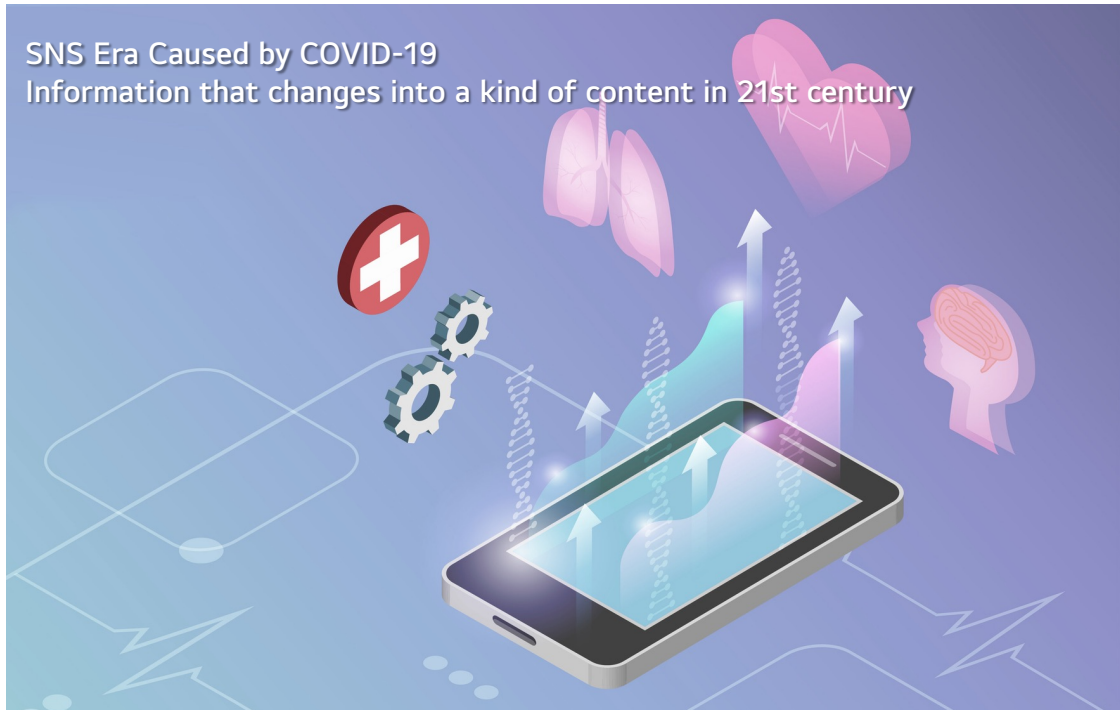

#### ❖ 2020 Digital Information Trend

- ✓ Acceleration of digital content due to COVID-19
  - ✓ Increase in volatile consumption patterns of digital content
  - ✓ Utilization as a means of storing value using NFT technology
  - ✓ Development of information providing service using artificial intelligence (AI)
- The development of digital content industry has been accelerated, as COVID-19 acts as a catalyst in the digital content field in 2020. With the rapid spread of COVID-19 in early 2020, countries around the world were faced with a situation where they had to deal with their existing business in a non-face-to-face manner. Digital solutions were quickly required to sustain remote work, business, healthcare, education, etc. In this situation, various people create contents based on information and share them, and users find and use the information they need.
  - The SNS industry coping with these changes of the times has triggered a major change in the information sharing field with remarkable growth. So, the innovation of information sharing market has been continuing as the 'interest, focus, and scope' on the potential of digital innovation have been greatly expanded.

## PART 1.0 MARKET

### 1.3. Problems & Solutions

#### ❖ Who owns content?

After the success of Yahoo, it has been proven that Internet service companies can accumulate enormous wealth.

Giant platform companies such as Naver, Google, Facebook, and Weibo were born. They selectively expose the various contents provided by individuals, and even if they do not produce contents, they record a lot of use time through competition between contents and make a lot of revenue.

As a result, content producers are repeatedly getting nothing but social honor.

✓ **The problems caused by the above can be summarized as three things as follows.**

#### Problem

1. Information with higher useful value is not shared.
2. It is difficult for value-sharers to obtain economic benefits
3. Valuable information is deteriorated, and the value is diluted.

✓ **And we propose CLEBUS Service as a solution to solve these problems.**

#### Solution

1. Supply of real-time valuable information sharing service and generation of valuable information through CLEBUS Platform
2. Storage of valuable information or data through CLE-NFT
3. Sharing everyday values through real-time communication

PART 2.0

# CLEBUS Project Introduction



## PART 2.0 CLEBUS Project Introduction

### 2.1. Project Promotion Background

Even now, numerous platform companies monopolize revenue using information. Platform companies are increasing their contents by obtaining overflowing information for free and the task of finding necessary information among the contents is passed on users. We would like to start CLEBUS service to lead these information services to a better level.

✓ **The three things that CLEBUS Service consider important are as following:**

❖ **Reliability of information**



Information is being thoughtlessly distributed only for hits. A lot of time and traffic are wasted due to this misleading information. Innumerable resources and time are being wasted. People want reliable and proven information having usefulness.

❖ **Volatility of information**

Many information on the online have become a simple entertainment for one time use. Once information is consumed, another stream of information floods in, causing the loss of important information. Such volatile information discourages the provider of information and makes it impossible to distinguish important information. We need a new way for information to be remembered and left behind.

❖ **Lack of reward**

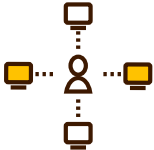
In the case of reward for providers that supply valuable information, most rewards are provided in the form of additional services, not in the form that is meaningful to the information itself. The method being used now is to provide some of the advertising revenues made on the platform for content creators. It is needed to provide value-focused rewards, not this way.

		
<p>Reliability of information</p>	<p>Volatility of information</p>	<p>Lack of reward</p>

## PART 2.0 CLEBUS Project Introduction

### 2.2. Project overview

It is difficult to expect a better world without solving the problem of information service, which is the critical thing in modern society. Although the way to spread other information through copying and pasting contributes to the spread of information, but this can make people forget respect a

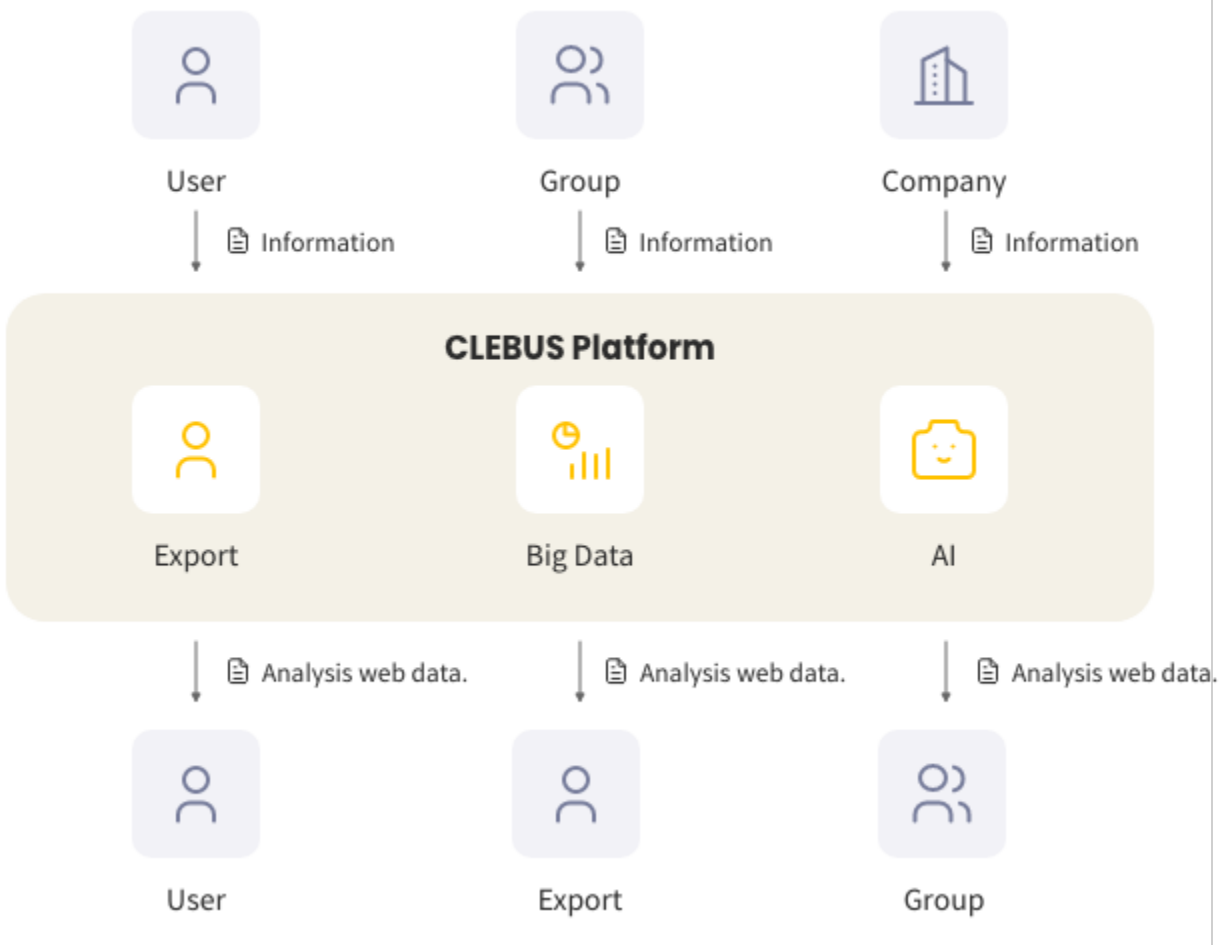

Therefore, all the people using CLEBUS can give their data to those who need it through CLEBUS platform. The data provided will be shared through the data web that was built in CLEBUS platform. This is very efficient compared to the time and cost required to receive data in the past, and it can solve the problem of personal information exposure of members who use the platform.

## PART 2.0 CLEBUS Project Introduction

### 2.3. CLEBUS Platform's Advantages

CLEBUS platform has three advantages. They are verification of decentralized method among users, tokenization of information (NFT), and reward & virtuous cycle.

#### 1. Trustworthy Data Foundation

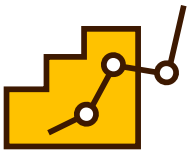

- 01 Completely reliable information through countless repetition of mutual feedback

---

- 02 Any user can participate in the verification of information

---

#### 2. Tokenization of Information (NFT)



- 01 Storage in a form that cannot be forged through blockchain

---

- 02 Storage or use on the platform in a secure form

---

#### 3. Reward & Virtuous Cycle



- 01 Payment of virtual asset when sharing data (analysis web)

---

- 02 Additional revenue through market value creation and transaction

---

## PART 2.0 CLEBUS Project Introduction

### 2.4. Expected Effects of CLEBUS Platform



#### Content consumers

They can enjoy or utilize only content that has been verified for reliability and usefulness.  
They can quickly and accurately share information from a group of verified experts.



#### Content providers

They can earn profits through their knowledge, information, and content creation activities.  
They can meet more users thanks to the reputation acquired through verification.



#### CLE (Ecosystem)

It can get quality content.  
It is possible to perform mutually reliable communication.  
It is possible to provide efficient service without wasting data and traffic.



## PART 2.0 CLEBUS Project Introduction

### 2.5. CLEBUS Coin Economy

The service users of CLEBUS Platform can be divided into data providers and data users. When someone subscribes membership, a CLEBUS Token wallet is automatically generated. When data providers upload their data they have, data users can use the web data analyzed by CLEBUS's experts and AI. The data users make a payment using CLEBUS coins that they have on the CLEBUS platform, and the CLEBUS platform pays CLEBUS coins to the data providers as rewards. The rewarded CLEBUS coins can be exchanged into cash in the exchange.

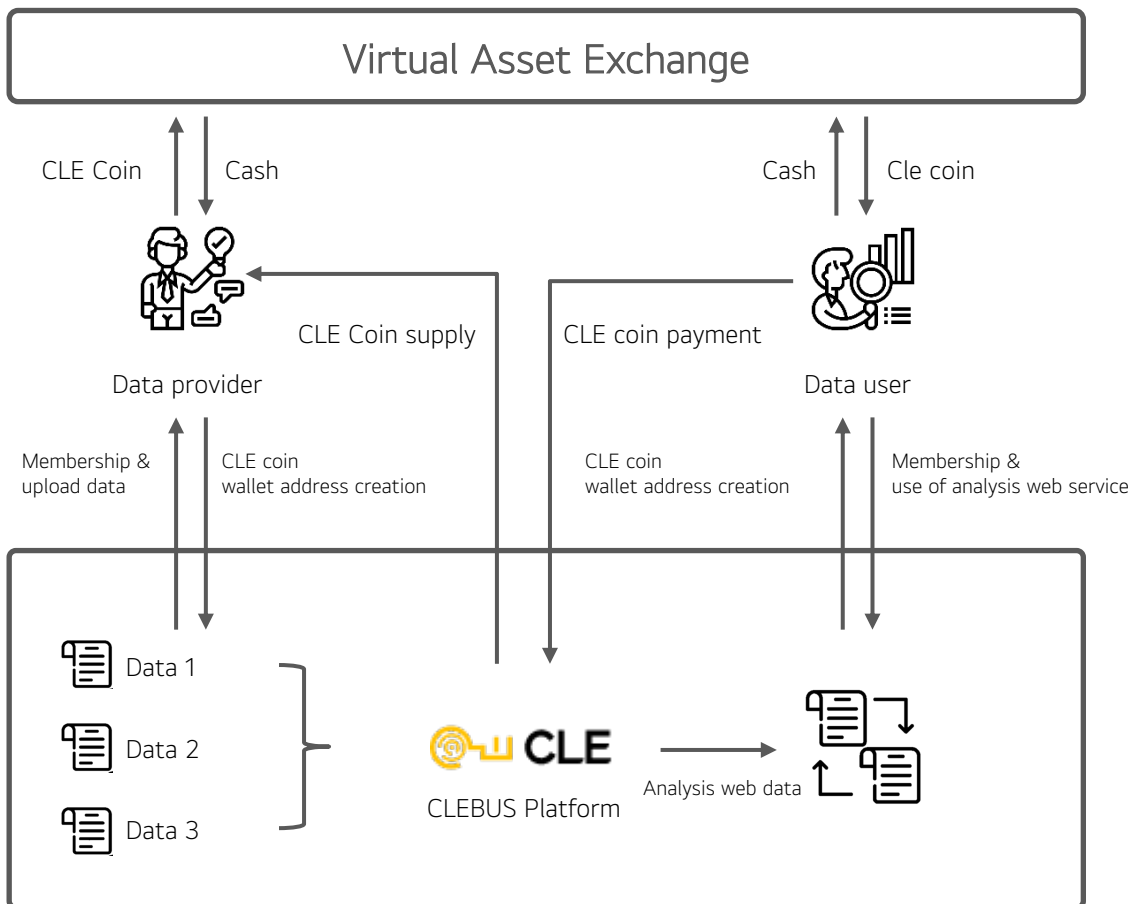

## PART 2.0 CLEBUS Project Introduction

### 2.5. CLEBUS Composition

CLEBUS can organically connect people who provide information, people who need it, and the collective intelligence that processes information. CLEBUS allows users to access the data network that they need through CLE-Build and provide real-time information exchange networks through CLE-BEAT. They categorize value through CLE Coin and CLE-NFT and perform expansion of production - reproduction - transaction process. CLE-Meta leads to a data ecosystem that more dynamically connects the virtual world and real-world information.

#### ❖ First Step to Create Value: CLE-BUILD

This is the first step of CLEBUS to access the desired service in a keyword method. You can get closer to the service you want, step by step, starting with a familiar search method.

Even if you are a user who contacts the CLE-BUILD for the first time, when you enter the keyword you want, the build menu is provided in the next step, and you can use the sea of information with several clicks. The more people participate in, the more information provided to the user will be more optimized through artificial intelligence and lead to the world of infinite information. You can see the infinite value of CLE ECO. Furthermore, users who want to provide or process information can store and register rich information there. The value of information grows as it is connected.

#### ❖ It sends signal of value: CLE-BEAT

As the heart beats and lives are connected, so modern society cannot be sustained without information flowing. It is a real-time information value service that allows you to update knowledge, information, news, opinions and feelings that you obtain in real time based on location.

Signal of value that CLE BEAT sends

- Real-time value registration using location-based (Range settings 100m~50km)
- Real-time value of information such as photo, video, voice, and location is registered.

The information I post is disseminated to those who need it in real time.

The usefulness of information can depend on the far-reaching power of its value. As users accept information as valuable one, those who register it can receive reward accordingly. You can also reward someone who provides essential information to you.

## PART 2.0 CLEBUS Project Introduction

### ❖ Next of NFT, CLE-NFT

Life-type NFT is the blockchain life service that CLEBUS introduces for the first time. Important events may be permanently preserved through NFT and may be presented, distributed, and sold to those who need it.

TRC-721 is applied to CLE-NFT, so it provides low fees, fast transmission speed, and high scalability.

Limited Edition NFT	Event Type NFT	Right Type NFT
Rights to take over new car, membership, and event participation right, etc. are issued as NFT and they may be sold or provided as a service for VIP.	Promotional materials or new launch products may be distributed and presented in NFT form.	Product ownership, intellectual property, copyright, etc. are made into NFT. The owners are guaranteed rights and buyers use it as a token of receiving right.

### ❖ CLEBUS Metaverse World: CLE-META

You can make a Meta world for yourself by combining a lot of information and connections. CLEBUS' metaverse is a next-generation platform for personalized space and time.

There is META for each interest in CLE-META where you create your own values. Various CLE-META s including intellectual property META, automobile META, coin META, household goods META, real estate META, business META, medical META , etc. are formed.

Users with the same interests gather and build a huge network of information within the meta. User s can meet people with similar tastes/ interests/ purposes within the metaverse, exchange various information, and even engage in economic activities such as sales. The place where all these METAs are gathered is CLEBUS.

PART 3.0

# Tech



## PART 3.0 CLEBUS TECH

### 3.1. CLEBUS blockchain

Bitcoin, best known for blockchain technology, is based on the POW (Proof of Work) consensus algorithm, and its block is generated when a number that is smaller than the hash value is found through a hash operation as Nonce value changes. The network method of Bitcoin called mining is calculated using GPU capable of multi-operation. The resources consumption and environmental problems that this mining method result in are gradually becoming an issue. Furthermore, the initial capital is much required, and the mining half-life of the Bitcoin is gradually decreasing. The Bitcoin blockchain platform using the mainnet only supports simple deposit and withdrawal functions, so it is not easy to introduce it to various services. Ethereum equipped with smart contracts that can be used in various services was born by compensating for the shortcomings of these technologies. Tron has the following features.

- 1) A platform with built-in currency and payment methods
- 2) A network environment where users have their own data sovereignty and applications do not steal my own data
- 3) An online service that anyone can access to the open financial system
- 4) A blockchain platform that is not controlled by a specific company or individual and has a neutral and open infrastructure

Tron, the currency of Tron, has many of the same features as Bitcoin. Tron is fully digitized and can be transmitted instantly to anyone, anywhere. And any government or any company cannot control the supply of Tron, like Bitcoin. That is to say, it is decentralized. People around the world are using this decentralized Tron as a payment method, a store of value, or collateral. However, unlike other blockchains, Tron can perform more functions. Tron can be used for programming, allowing developers to create new kinds of applications using Tron.

## PART 3.0 CLEBUS TECH

### 3.2. CLEBUS network layer

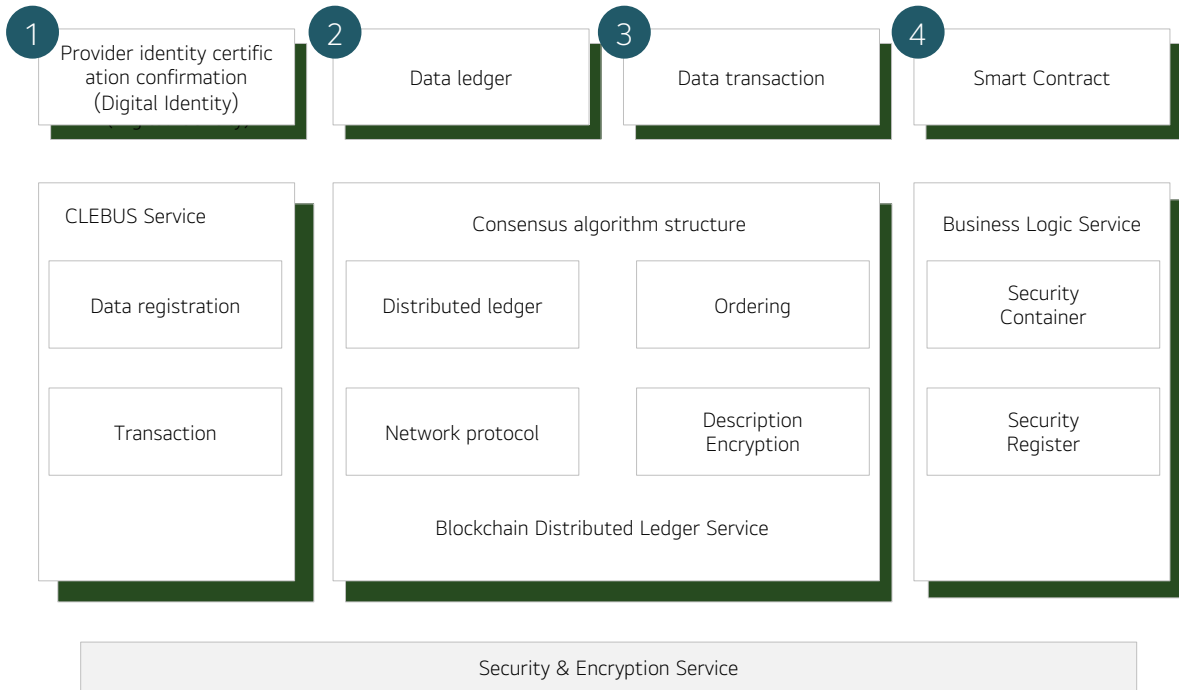

① This is the identity confirmation process layer for securing CLEBUS data. It is required for users to certify DID to generate a transaction in CLEBUS. This provides the function to store data and issue related certifications so that participants can record, modify, and delete research contract related data on the distributed ledgers.

② This is ledger. CLEBUS's distributed ledger system has a structure that integrates an Ethereum chain. It is a database that manages data in order to store data as a basic component of the blockchain. The structure of the ledger consists of functions to manage and process it.

③ This is a component and transaction information layer. This is a layer that manages transactions created in blockchain service processing. It assigns the Endorsement Validation to process the transaction and generates a block. There is a distributed ledger service that plays a role to branch to all participating nodes.

④ This is a Smart Contract component layer. A smart contract has an important function in the blockchain. It realizes the logic to utilize the blockchain in accordance with the services made through the consortium. Smart contracts basically support logic development in various languages.

## PART 3.0 CLEBUS TECH

### 3.3. CLEBUS BLOCKCHAIN

#### CLEBUS Blockchain POINT

- ① Realization of various event functions of the CLEBUS service using smart contract
- ② Operations according to their own token issuing policy (journal subscription, publisher, analysis platform, etc.)
- ③ Personal and institutional network services using online/offline data through various research institutes, developers, and TFT collaboration
- ④ Second security management using multi-signature address channel

The traditional system must establish a reliable data institution that manages transaction information into a centralized type, and a high social cost is required for securing and operating the trust of the institution. On the other hand, the CLEBUS system based on blockchain distributes collected information to a P2P(Peer-to-Peer) network, not a central server of a particular institution, so that the participating members can record and manage the information. Therefore, it is unnecessary for manpower and resource input to operate trusted third agencies and all transaction records are encrypted and disclosed to members, so the transparency of the data can be enhanced. In terms of security, it has a structure that secures safety and an architecture that can maximize the security service of the platform.

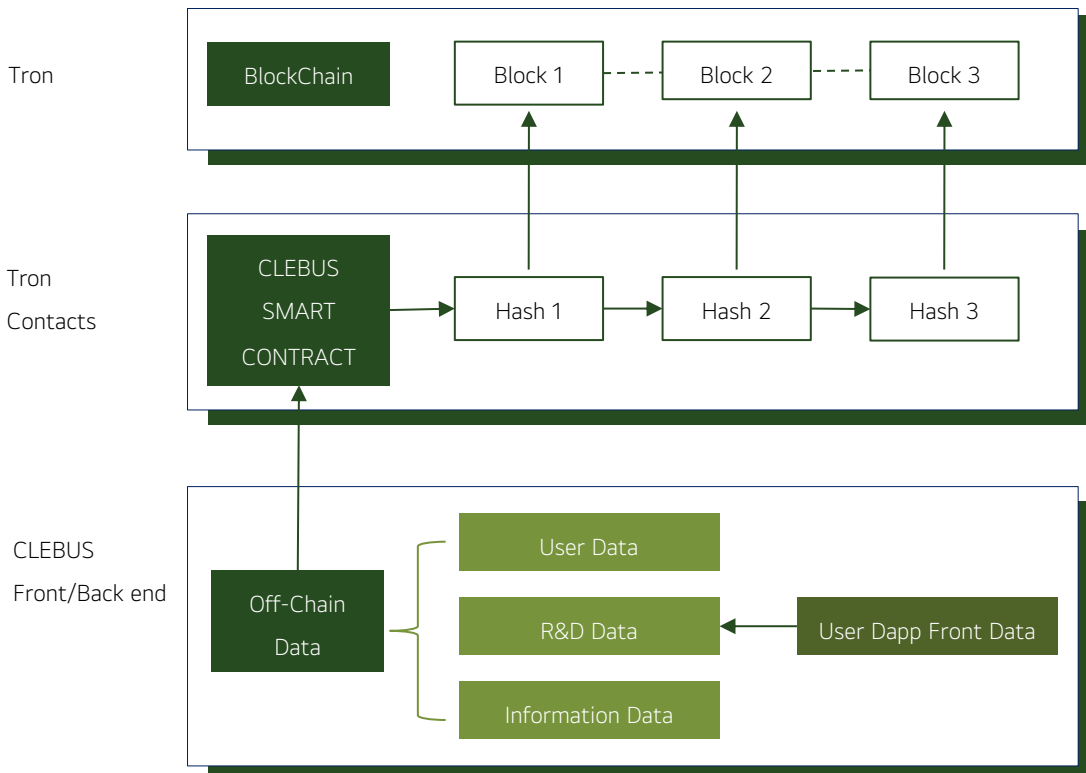

## PART 3.0 CLEBUS TECH

### 3.4 CLEBUS Token Economy

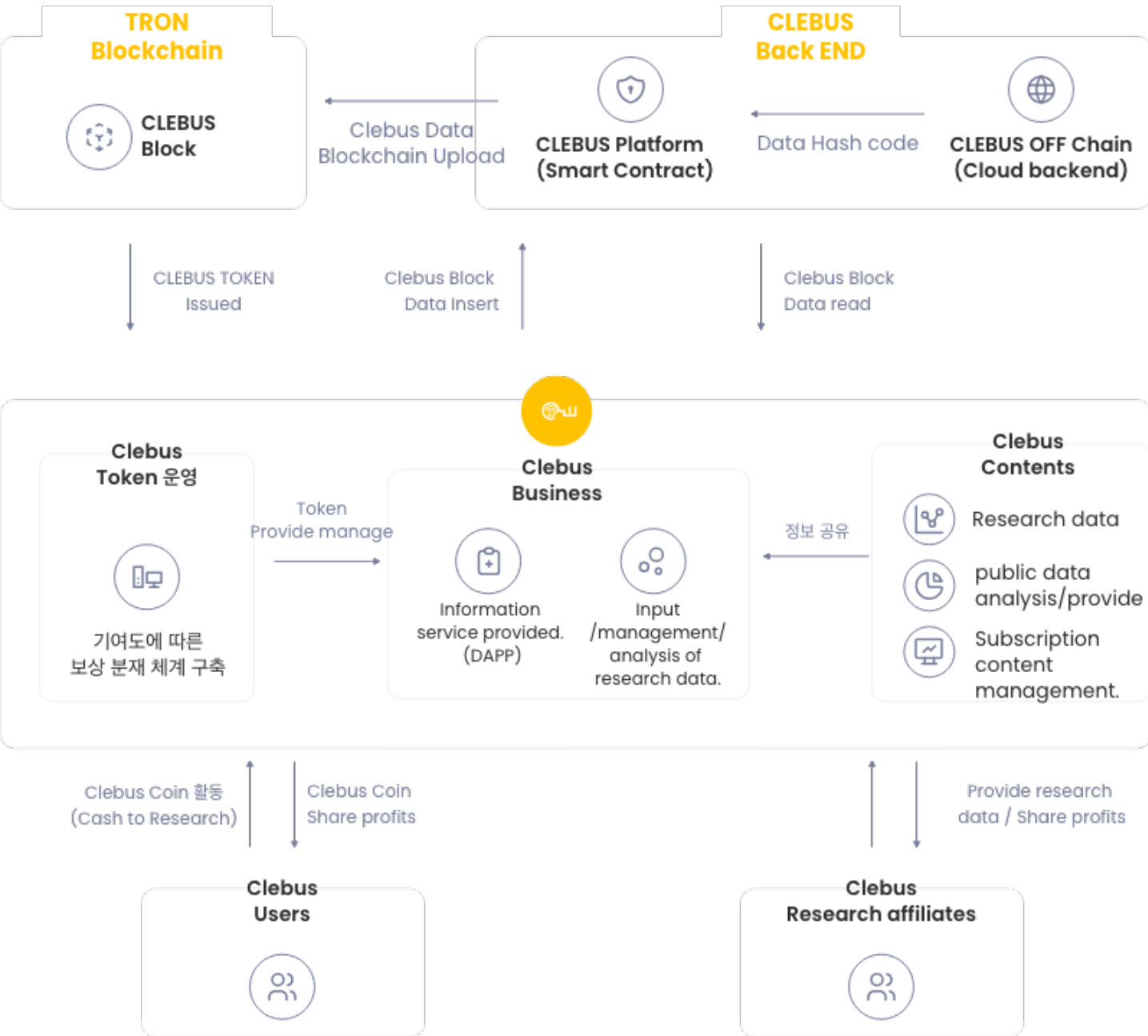



PART 4.0

# Distribution

## PART 4.0 TOKEN DISTRIBUTION

### ❖ TOKEN MATRIX

Token Name	CLECOIN	Token Symbol	CLE
Algorithm	TRX TRC-20	Decimals	6
Total Token Supply	10,000,000,000 CLE		

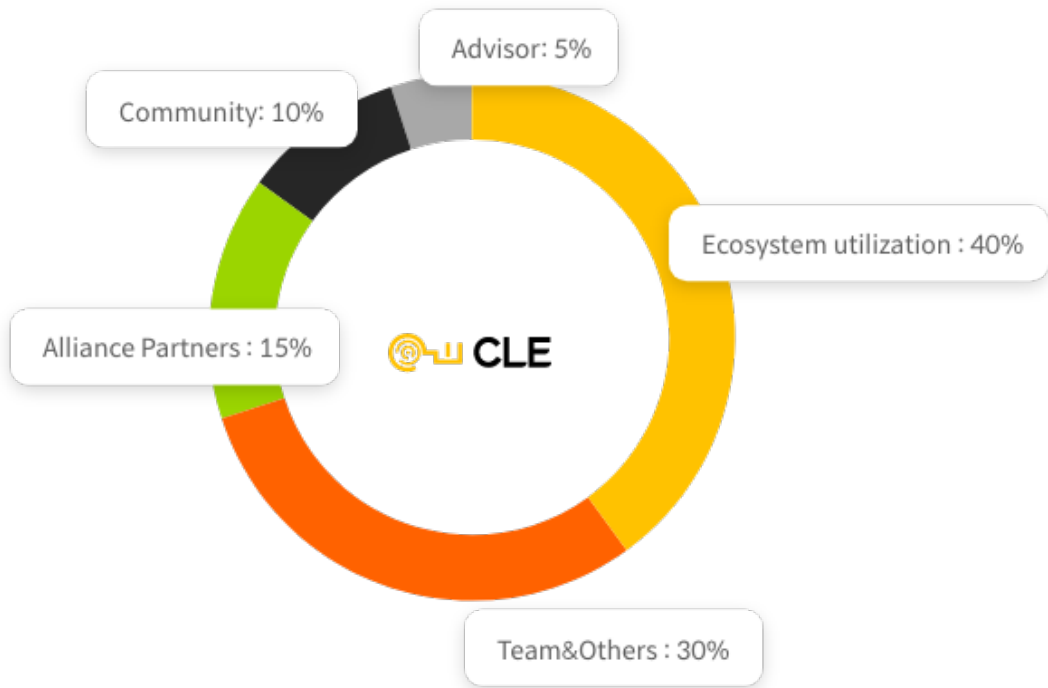

- (1) Alliance Partner: It is distributed to Alliance Partners.
- (2) Community: It is distributed to the community of CLEBUS PROJECT.
- (3) Advisors: It is distributed to advisors of the CLEBUS foundation participating in CLEBUS PROJECT.
- (4) Team & Others: It is distributed to team members of CLEBUS PROJECT.
- (5) Ecosystem & Utilization: It is used for distribution volume adjustment and ecosystem.

PART 5.0

# Roadmap

## PART 5.0 ROAD MAP

### ▪ CLEBUS ROAD MAP

Area	Description	2021		2022				2023	
		Q3	Q4	Q1	Q2	Q3	Q4	Q1	
Plan	CLEBUS Planning	[Yellow bar]							
Dev	CLECOIN & wallet development	[Dark grey bar]							
Sales	Made strategic partnership agreement		[Yellow bar]						
Listing	First exchange listing			[Dark grey dot]					
Dev	CLEBUS ecosystem composition		[Yellow bar]						
Dev	CLE BUILD development			[Dark grey bar]					
Dev	CLE NFT development				[Yellow bar]				
Dev	CLE BEAT development						[Dark grey bar]		
Beta OPEN	CLEBUS OPEN Beta				[Yellow dot]				
M.K.T	CLEBUS M.K.T		[Dark grey bar]						
Listing	Second exchange listing						[Yellow dot]		
M.K.T	CLEBUS M.K.T (Global)					[Dark grey bar]			



PART 6.0

# Disclaimer

## PART 6.0 DISCLAIMER

Please read carefully all the information in the disclaimer of this white paper. If you do not know how to act in the future, we recommend you seek the opinions of legal, financial, tax, and other experts.

### 1. Disclaimer

(a) This white paper has been distributed for general reference purposes only in relation to the CLEBUS project since it was written and may be reviewed and revised. Please note that this white paper reflects the latest information as of the date on the cover and is not final version. After that date, the information in this document such as CLEBUS tokens, business operations, financial status, etc. is subject to change. This white paper may be updated on occasional basis.

(b) No one does not have a duty to sign a contract or legal binding pledge associated with the trading of CLEBUS token and should not receive funds based on this white paper. The trading of CLEBUS tokens is carried out through the CLEBUS platform and the related details will be announced separately from this white paper.

(c) This white paper shall not be construed as a token sale or purchase offer by the CLEBUS token issuer/distributor/company. Contracts and investment decisions must not be based on or rely on the presentation of this document or the document itself.

(d) CLEBUS Token is not intended to constitute units of securities and business trusts, or collective investment plans. Each definition of this follows the definition set forth in the equivalent regulations of the jurisdiction in which the business is located. Therefore, this white paper is not provided as a business plan, business prospectus, proposal, etc., and should not be construed as an investment proposal or solicitation for units of securities and business trusts, units of collective investment plans, etc. in any jurisdiction.

(e) CLEBUS Token should not be understood, interpreted, classified, or treated as an opportunity to participate in the CLEBUS service or receive part of the investment/ income/ payment/ profit, or the part of the money.

(f) In a regulatory or prohibited jurisdiction in this white paper, the entire or part of this document can not be copied, distributed, and disseminated.

If you want to purchase CLEBUS tokens, you should not understand, classify, and treat them as following things: a) any currency other than cryptocurrency; b) bonds and stocks issued by any institution; c) rights, options and derivatives in these bonds and stocks; d) rights under contracts for difference and other contracts for the purpose of or pretending to be for the purpose of ensuring return on investment or avoiding losses; e) a unit of securities or derivatives such as collective investment plans and business trusts.

### 2. Restrictions of Distribution & Dissemination

(a) It may be prohibited and restricted by the law or regulatory requirements of any jurisdiction to distribute and disseminate all or part of this white paper. If restrictions are applied, you should be aware of the restrictions that can be applied due to the possession of this white paper, seek advice on the relevant laws, etc., and comply with them. The foundation operating CLEBUS, CLEBUS's employees, agents, and affiliates, etc. (hereinafter referred to as 'CLEBUS foundation and its affiliates'), etc., are not responsible for it.

(b) If you read or possess this white paper due to deployment and dissemination, you must not allow or cause a situation to share this white paper or its contents with others, in any method including distribution, duplicate, etc. regardless of purpose.

## PART 6.0 DISCLAIMER

### 3. Disclaimer

(a) The relevant services provided by the CLEBUS foundation and its affiliates are provided as 'as it is', 'as soon as practicable'. CLEBUS foundation and its affiliates do not guarantee or describe implicitly/explicitly the accessibility, quality, suitability, accuracy, appropriateness, and completeness, etc. of CLEBUS token and related services. We also specify that we do not have any responsibility for errors, delays, missing, or actions taken accordingly.

(b) CLEBUS Foundation and its affiliates do not describe, guarantee, promise and assert truth, accuracy and perfection of the information contained in this white paper regardless of form.

(c) CLEBUS Foundation and its affiliates do not have legally responsible for any indirect, special, incidental, resulting losses (Including, but not limited to, loss of investment revenue/income/profit, loss of data, etc.) caused by accepting or dependent on the whole or part of this white paper, and this applies within the maximum of the relevant legal regulations.

### 4. Warning on Forward-looking Statements

(a) The specific expressions stated in this white paper contain forward-looking statements regarding the future, future events and prospects of this project. These things are not statements based on historical facts, but are considered expressions similar to the words such as 'plan,' 'estimate,' 'belief,' 'expectation,' 'prospect,' 'anticipation' etc. In addition to this white paper, these forward-looking statements may also be included in other publicly available materials such as presentations, interviews, videos, etc. The forward-looking statements contained in this white paper include, but are not limited to, the future results, performance, and achievements of CLEBUS Foundation and its affiliates.

(b) Forward-looking statements involve a variety of risks and uncertainties. These statements do not guarantee future performance, so you should not rely on it excessively. When risks and uncertainties materialize into reality, the actual performance and development of CLEBUS foundation and its affiliates may differ from expectations made by forward-looking statements. Even if these circumstances change in the future, the CLEBUS foundation and its affiliates have no obligation to provide updates on forward-looking statements. If you act on the basis of forward-looking statements contained in this white paper, the websites of CLEBUS foundation and it affiliates, and other materials, you are solely responsible for the non-realization of forward-looking statements.

(c) As of the date this white paper was written, CLEBUS project is not completed or fully operational. Although this description has been written on the premise that CLEBUS project will be complete and fully operational in the future, this should not be construed as any guarantee or promise that CLEBUS project will be complete or fully operational.

### 5. Potential Risk

(a) We recommend that you read the following carefully, analyze thoroughly and understand the relevant factors and risks before deciding to purchase CLEBUS tokens and participate in the project. Risks include but are not limited to the following: (i) Risk of buyer negligence related to security, such as restriction of access to CLEBUS tokens due to loss of identification information and loss of essential private keys related to digital wallets storing CLEBUS tokens, (ii) Risk of change in value after issuance of CLEBUS tokens due to global market and economic conditions. This uncertainty in the value of the CLEBUS token may prevent the CLEBUS Foundation from funding the development of the CLEBUS token ecosystem or maintaining the ecosystem in the intended direction.



## PART 6.0 DISCLAIMER

(iii) Risk related to change in politics, society and economic environment, change in stock or cryptocurrency market environment, change in the regulatory environment of countries that CLEBUS foundation and its affiliates operate this business, and change of CLEBUS foundation and its affiliates' ability to survive or compete in this environment. Existing/new regulations associated with blockchain technology, which is disadvantage to CLEBUS token in a particular jurisdiction, may be applied. Therefore, a significant change in the ecosystem and projects of CLEBUS token including CLEBUS token disuse/loss, etc.

may occur. (iv) Risk related to change in future capital needs of CLEBUS foundation and its affiliates and change in capital and financing possibilities to meet them. Lack of funds may affect not only the development of CLEBUS platform but also the use and potential value of CLEBUS token. (v) CLEBUS project may be interrupted and dismantled, or the launching plan can be interrupted due to various reasons including disadvantageous change of CLEBUS token value, business relationship failure, competitors' knowledge property claim during development/operation, etc. This may cause a negative impact on CLEBUS token ecosystem, CLEBUS token, and the potential utilization of CLEBUS token. (vi) Risk related to the lack of interest in the CLEBUS project and services by other organizations, such as companies and individuals, as well as the limited public interest in the creation and development of distributed applications. Lack of this interest may limit funding or affect the CLEBUS project development as well as the utilization and potential value of CLEBUS token. (vii) Risk to apply major changes to the main functions and specifications of the CLEBUS project before launching or implementing the CLEBUS project and ecosystem. Although CLEBUS intends that CLEBUS token and its functions will be consistent with the content of the white paper, these changes may still be applied. (viii) Risk of competition with other platforms that could potentially adversely affect both CLEBUS token and CLEBUS platform. (For example: when it does not achieve commercial success due to competitive projects or has gloomy prospects) (ix) Risk that the third party or other people plant harmful and malicious codes to CLEBUS project and interfere with the infrastructure and use of CLEBUS tokens regardless of the intent. The blockchain used in the CLEBUS project is also vulnerable to such attacks, which poses a risk to the operation of the project and related services. (x) Due to the occurrence of catastrophic events such as force majeure and natural disasters, the business operations and other things of CLEBUS foundation and its affiliates may be affected. Theft and loss of CLEBUS token and token sales due to mining attacks, attacks of hackers or other individuals, and deterioration of capability for CLEBUS token ecosystem development, etc. may occur. CLEBUS token and other cryptocurrencies are new technologies that have not yet verified, and they continue to develop. The function of the CLEBUS token has not yet completed fully and there is no guarantee of its completion. As technology develops, advancements in encryption technology and methods, changes in consensus protocols and algorithms, etc. may act as risks to CLEBUS token, sales of CLEBUS token, CLEBUS project, CLEBUS token ecosystem, and utilization of CLEBUS tokens. (xii) CLEBUS token does not empower any other subjects to make any decisions related to the CLEBUS project, the CLEBUS ecosystem, etc. All decisions related to CLEBUS products and services, stop of CLEBUS token ecosystem, additional creation and sales of CLEBUS tokens, sale and liquidation of CLEBUS, etc. are performed at the discretion of CLEBUS platform. (xiii) CLEBUS token taxation and accounting practices are uncertain and may vary according to jurisdiction. The purchase of CLEBUS tokens may have a negative impact on tax processing, and we recommend that you seek independent tax advice. In addition to the stated risks, there may be other risks that CLEBUS foundation and its affiliates cannot predict. There may also be risks of unexpected combinations and variations.

(b) When the above risks and uncertainties develop into actual situations, CLEBUS foundation and its affiliates' businesses, financial status, operational results, outlook, etc. may be negatively affected. This may cause you to lose some or all of the CLEBUS token's value.

## **PART 6.0 DISCLAIMER**

### **6. No Additional Information or Updates**

No one has the authority to provide information/descriptions other than the contents on CLEBUS foundation and its affiliates, and related business and operations included in this whitepaper. Even if the information/description is provided, it should not be considered as CLEBUS foundation and its affiliates impose their authority to others, or someone represents them.

### **7. No Advice**

Any information contained in this white paper is not considered advice on business, law, finance or taxation for CLEBUS tokens, CLEBUS foundation or its affiliates. We recommend that you seek expert opinions on law, finance, and taxation for CLEBUS token, CLEBUS foundation, and related business and operations. The financial risk of purchasing CLEBUS tokens may be applied without a time limit.

# CLEBUS PROJECT

[Blockchain-Based Integrated Medical Data Service]

## E.O.D

Clecoin is a TRC-based value trading tool used in the CLEBUS ecosystem. Value creators, value users, and value sharers are rewarded with Clecoin for the value they create, use, or share. Value users consume Clecoin to use value, and value sharers receive rewards for sharing.